



*Best High Integration/Low Cost USB Audio Controller
for PC Internet Phone*

CM119 USB I/O Controller DataSheet

Version 1.0

C-MEDIA ELECTRONICS INC.

TEL: 886-2-8773-1100 FAX: 886-2-8773-2211

6F, 100, Sec. 4, Civil Boulevard, Taipei, Taiwan 106, R.O.C.

For detailed product information, please contact sales@cmedia.com.tw

NOTICES

THIS DOCUMENT IS PROVIDED "AS IS" WITH NO WARRANTIES WHATSOEVER, INCLUDING ANY WARRANTY OF MERCHANTABILITY, NONINFRINGEMENT, FITNESS FOR ANY PARTICULAR PURPOSE, OR ANY WARRANTY OTHERWISE ARISING OUT OF ANY PROPOSAL, DOCUMENT OR SAMPLE.

ALL RIGHTS RESERVED. NO PART OF THIS DOCUMENT MAY BE REPRODUCED OR TRANSMITTED IN ANY FORM OR BY ANY MEANS, ELECTRONIC OR MECHANICAL, INCLUDING INFORMATION STORAGE AND RETRIEVAL SYSTEMS, WITHOUT PERMISSION IN WRITING FROM C-MEDIA ELECTRONICS, INC.

COPYRIGHT

Copyright (c) 2003-2008 C-Media Electronics Inc.

All rights reserved. All content included on this document, such as text, graphics, logos, button icons, images, audio clips, digital downloads, data compilations, and software, is either the exclusive property of C-Media Electronics Inc., its affiliates (collectively, "C-Media"), its content suppliers, or its licensors and protected by Republic of China and international copyright laws.

TRADEMARKS

C-Media, the C-Media Logo, Xear 3D, Xear 3D Logo, Speaker Shifter, Smart Jack, and Smart Audio Jack are trademarks of C-Media Electronics Inc. in Republic of China and/or other countries. All other brand and product names listed are trademarks or registered trademarks of their respective holders and are hereby recognized as such.

C-Media reserves the right to modify the specifications without further notice

TABLE OF CONTENTS

1. DESCRIPTIONS AND OVERVIEW	4
2. FEATURES	4
3. PIN DESCRIPTIONS	6
3.1 PIN ASSIGNMENT BY PIN NUMBER	6
3.2 PIN-OUT DIAGRAM	6
3.3 PIN SIGNAL DESCRIPTIONS	7
4. MCU INTERFACE	9
5. BLOCK DIAGRAM	9
6. ORDERING INFORMATION	10
7. FUNCTION DESCRIPTIONS	11
7.1 USB INTERFACE	11
7.1.1 DEVICE DESCRIPTOR	11
7.1.2 CONFIGURATION DESCRIPTOR	12
7.1.3 CONTENT FORMAT FOR 94C46	12
7.1.4 USB AUDIO TOPOLOGY DIAGRAM	13
7.2 JUMPER PINS AND MODE SETTING	13
7.3 HID FEATURE	14
7.3.1 HID DESCRIPTOR	15
7.3.2 WINDOWS SOFTWARE ARCHITECTURE FOR HID	16
7.4 INTERNAL REGISTERS	16
7.4.1 ACCESS VIA HID CLASS COMMAND	16
7.4.2 ACCESS VIA INTERNAL INTERFACE BY MCU	19

7.4.3	INDIRECT ACCESSED REGISTERS	22
7.5	MCU INTERFACE	23
7.6	BUZZER OUTPUT	28
8.	ELECTRICAL CHARACTERISTICS	29
8.1	ABSOLUTE MAXIMUM RATING	29
8.2	OPERATION CONDITIONS	29
8.3	ELECTRICAL PARAMETERS	30
9.	FREQUENCY RESPONSE GRAPHS	31
9.1	DIGITAL PLAYBACK FOR LINE OUTPUT FREQUENCY (10K OHM LOADING)	31
9.1.1	FREQUENCY RESPONSE 48KS/SEC	31
9.1.2	FREQUENCY RESPONSE 44.1KS/SEC	31
9.2	DIGITAL PLAYBACK FOR LINE OUTPUT FREQUENCY (32 OHM LOADING)	32
9.2.1	FREQUENCY RESPONSE 48KS/SEC	32
9.2.2	FREQUENCY RESPONSE 44.1KS/SEC	32
9.3	DIGITAL RECORDING FOR LINE OUTPUT FREQUENCY	33
9.3.1	FREQUENCY RESPONSE 48KS/SEC	33
9.3.2	FREQUENCY RESPONSE 44.1KS/SEC	33
10.	APPLICATION CIRCUIT REFERENCE	34

1. DESCRIPTIONS AND OVERVIEW

CM119 is a highly integrated single chip USB audio controller specifically for VoIP (Voice over internet protocol) application. All essential analog modules are embedded in CM119, including dual DAC and earphone driver, ADC, microphone booster, PLL, regulator, and USB transceiver. 8 GPIO pins can constitute a 24 key matrix directly support keypad control function without MCU. It's also support buzzer output pin for VoIP application. In addition, audio adjustment can be easily controlled via specific HID compliant volume control pins. Many features are programmable with jumper pins or external EEPROM. Vender can customized unique USB VID/PID to EEPROM for VoIP software authentication. Moreover, individual unique phone number for each device is possible via serial number stored in external EEPROM. Moreover, CM119 provided I2C interface with MCU application for LCM integrated and advanced functions.

VoIP applications are becoming increasing popular as VoIP can provide free or low-cost calling worldwide. To provide a VoIP experience that is the same as using a regular phone and eliminate the poor call quality that results from using the PC audio, C-Media has developed CM119 USB Controller that enables a regular phone, handset, or headset which is interfaced to the USB port on the PC. With the C-Media OEMs can quickly bring to market a family of low cost high quality VoIP products.

2. FEATURES

- Compliant with USB 2.0 Full Speed Operation
- Compliant with USB Audio Device class specification v1.0
- Supports USB Suspend/Resume Mode and remote Wakeup with Volume Control pins
- Single 12MHz Crystal input with on-chip PLL and embedded USB transceiver
- Jumper Pin for Speaker Mode (Playback Only) or Headset Mode (Playback + Recording)
- For Headset Mode, USB audio function topology has 2 Input Terminals, 2 Output Terminals, 1 Mixer Unit, 1 Selector Unit, and 3 Feature Units
- Jumper Pin for Operation System Mixer Unit Enable/Disable under Headset Mode

- For Speaker Mode, USB audio function topology has 1 Input Terminal, 1 Output Terminal, and 1 Feature Unit
- Support one Control Endpoint, one Isochroous out Endpoint, one Isochroous in Endpoint, and one Interrupt in Endpoint
- Alternate zero bandwidth setting for releasing playback bandwidth on USB Bus when this device is inactive
- Volume up, volume down, and playback mute support USB HID for Host Control Synchronization
- Record Mute Pin with LED Indicator for Record Mute Status
- External EEPROM Interface for Vendor Specific USB VID, PID, and Serial Number
- Supports AES/EBU, IEC60958, S/PDIF Consumer Formats for Stereo PCM Data at S/PDIF Output
- 8 GPIO Pins with Read/Write via HID
- Embedded Buzzer Function controlled by Register
- Support I2C Interface for External MCU Integrated
- Jumper Pin for Output Voltage Swing (3.5V or 2.5V)
- Jumper Pin for Power Mode Setting
- Isochroous transfer uses Adaptive Mode with Internal PLL for Synchronization
- 48K/44.1KHz Sampling Rate for both Playback and Recording
- Soft Mute Function
- Embedded High Performance 16 bit audio DAC with Earphone Phone Buffer
- Host side data loss noise reduction function
- Embedded 16 bit ADC input with Microphone Boost
- Embedded power on Reset Block
- Embedded 5V to 3.3V regulator for single External 5V Operation
- Compatible with Win98 SE / Win ME / Win 2000 / Win XP and Mac OS9 / OS X without Additional Driver
- 48 Pin LQFP Package
- Support Hardware SDK tool for third-party software or soft-phone development

3. PIN DESCRIPTIONS

3.1 PIN ASSIGNMENT BY PIN NUMBER

Pin #	Signal Name	Pin #	Signal Name	Pin #	Signal Name	Pin #	Signal Name
1	SPDIFO	13	GPIO3	25	VBIAS	37	REGV
2	DW	14	DVSS1	26	VREF	38	MSEL
3	DR	15	GPIO4	27	MICIN	39	VOLUP
4	SK	16	GPIO5	28	VSEL	40	PDSW
5	CS	17	GPIO6	29	AVDD1	41	USBDP
6	MUTER	18	MUTEP	30	LOL	42	USBDM
7	PWRSEL	19	BUZZ	31	LOBS	43	GPIO1
8	XI	20	GPIO7	32	LOR	44	SCLK
9	XO	21	LEDR	33	AVSS2	45	MINT
10	MODE	22	GPIO8	34	AVDD2	46	SDAT
11	GPIO2	23	TEST	35	DVDD	47	MCLK
12	LEDO	24	AVSS1	36	DVSS2	48	VOLDN

3.2 PIN-OUT DIAGRAM

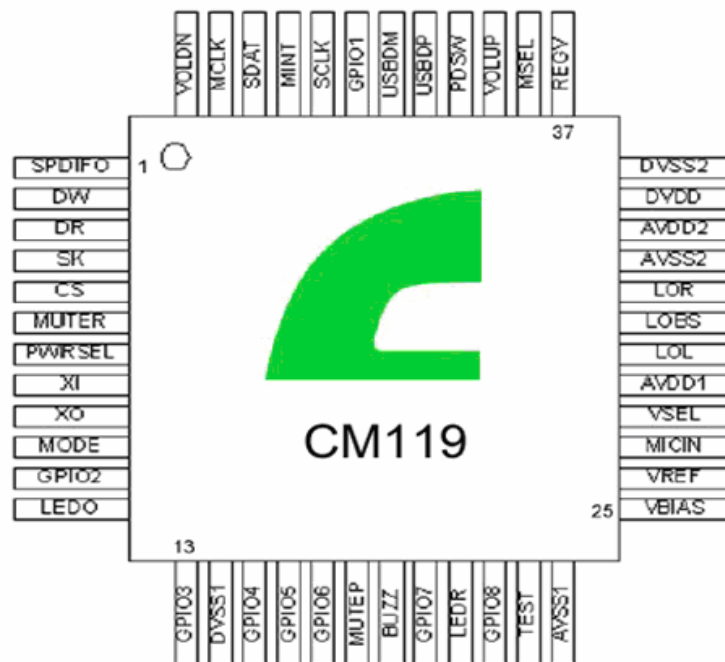

Pin Assignments (Top View)

3.3 PIN SIGNAL DESCRIPTIONS

Pin #	Symbol	Type	Description
1	SPDIFO	DO, 8mA, SR	SPDIF Output
2	DW	DIO, 8mA, PD, 5VT	USB Controller Data Read From EEPROM Interface. EEPROM Data Output.
3	DR	DO, 4mA, SR	USB Controller Data Writes to EEPROM Interface. EEPROM Data Input.
4	SK	DO, 4mA, SR	EEPROM Interface Clock (100KHz)
5	CS	DO, 4mA, SR	EEPROM Interface Chip Select
6	MUTER	DI, ST, PU	Mute Recording (Edge Trigger with de-Bouncing)
7	PWRSEL	DI, ST	H: Pull Up to 3.3V; L: Pull Down to Ground Speaker Mode H : Self Power with 100mA ; L : Bus Power with 500mA Headset Mode H : Bus Power with 100mA ; L : Bus Power with 500mA
8	XI	DI	Input Pin for 12MHz Oscillator
9	XO	DO	Output Pin for 12MHz Oscillator
10	MODE	DI, ST	H: Pull Up to 3.3V; L: Pull Down to Ground L : Headset Mode: Playback & Recording H : Speaker Mode: Playback Only
11	GPIO2	DIO, 8mA, PD, 5VT	GPIO Pin
12	LEDO	DO, SR, 8mA	LED for Operation; Output H for Power On; Toggling for Data Transmit
13	GPIO3	DIO, 8mA, PD, 5VT	GPIO Pin
14	DVSS1	P	Digital Grounding
15	GPIO4	DIO, 8mA, PD, 5VT	GPIO Pin
16	GPIO5	DIO, 8mA, PD, 5VT	GPIO Pin
17	GPIO6	DIO, 8mA, PD, 5VT	GPIO Pin
18	MUTEP	DI, ST, PU	Mute Playback (Edge Trigger with de-Bouncing)
19	BUZZ	DO, 8mA, SR	Buzzer Output Pin
20	GPIO7	DIO, 8mA, PD, 5VT	GPIO Pin
21	LEDR	DO, SR, 8mA	LED for Mute Recording Indicator; Output H when Recording is Muted
22	GPIO8	DIO, 8mA, PD, 5VT	GPIO Pin
23	TEST	DI, ST, PD	Test Mode Select Pin; Pull Low for Normal Operation
24	AVSS1	P	Analog Ground

25	VBIAS	AO	Microphone Bias Voltage Supply (4.5V)
26	VREF	AO	Connecting to External Decoupling Capacitor for Embedded Bandgap Circuit; 2.25V Output
27	MICIN	AI	Microphone Input
28	VSEL	AI	Line Out Voltage Swing Select H: Pull Up to 5V, L: Pull Down to Ground L: 2.5Vpp Output ; H: 3.5Vpp Output
29	AVDD1	P	5V Analog Power for Analog Circuit
30	LOL	AO	Line Out Left Channel
31	LOBS	AO	DC 2.25V Output for Line Out Bias
32	LOR	AO	Line Out Right Channel
33	AVSS2	P	Analog Ground
34	AVDD2	P	5V Analog Power for Analog Circuit
35	DVDD	P	5V Power Supply to Internal Regulator
36	DVSS2	P	Digital Grounding
37	REGV	AO	3.3V Reference Output for Internal 5V → 3.3V Regulator
38	MSEL	DI, ST	Mixer Enable Select H: Pull Up to 3.3V, L: Pull Down to Ground L: Without Mixer; H: With Mixer (With Default Mute) USB Descriptors are changed accordingly
39	VOLUP	DI, ST, PU	Volume Up (Edge Trigger with de-Bouncing)
40	PDSW	DO, 4mA, OD	Power Down Switch Control (for PMOS Polarity) 0: Normal Mode, 1: Power Down Mode
41	USBDP	AIO	USB Data D+
42	USBDM	AIO	USB Data D-
43	GPIO1	DIO, 8mA, PD, 5VT	GPIO Pin
44	SCLK	DIO, 8mA, PD, 5VT	External MCU Serial Bus Clock Pin
45	MINT	DO, 4mA, SR	External MCU Interrupt Pin When Register Address 4 ~ 7 has new data, MINT is set Low; after MCU read MINT is reset to H
46	SDAT	DIO, 8mA, PD, 5VT	External MCU Serial Bus Data Pin
47	MCLK	DO, 4mA, SR	External MCU Clock Pin, Clock Frequency is Programmable Default is 1.5 MHz (Options Include, 6MHz, 3MHz, 1.5MHz)
48	VOLDN	DI, ST, PU	Volume Down (Edge Trigger with de-Bouncing)

Note: DI – Digital Input Pad, DO – Digital Output Pad, DIO – Digital bi-Directional Pad, AI/AO/AIO – Analog Pad, SR Slew Rate Control, ST – Schmitt Trigger, PD/PU – Pull Down or Pull Up, 5VT – 5 Volt Tolerant (3.3V Pad), OD – Open Drain

4. MCU INTERFACE

CM119 provides a serial MCU Interface for external MCU to access internal registers with these registers access. MCU and host side software can have bi-directional communication. This interface can keep flexibility for external module control and integrate, such as LCD panel.

5. BLOCK DIAGRAM

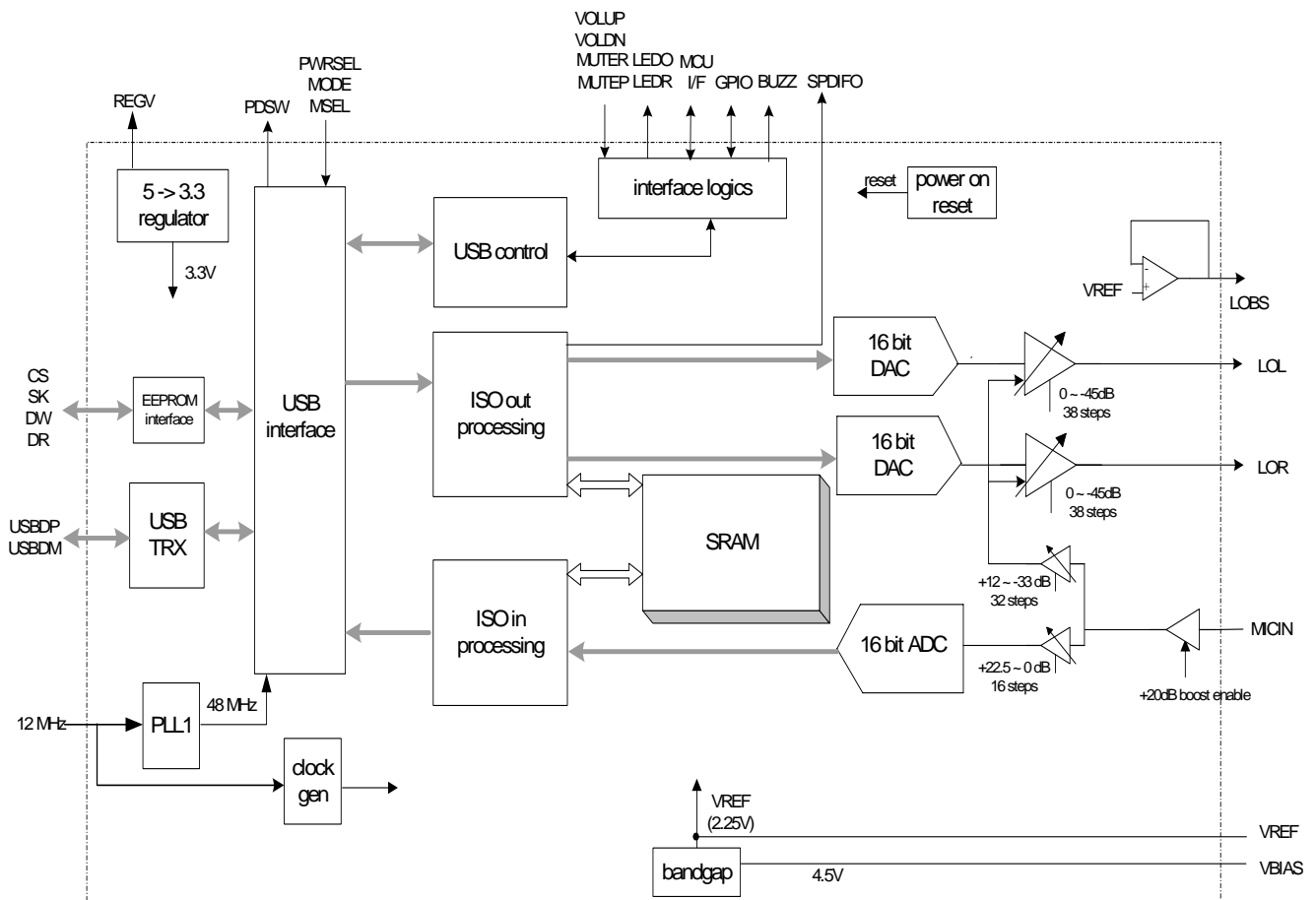

Block Diagram Of CM119

6. ORDERING INFORMATION

Model Number	Package	Operating Ambient Temperature	Supply Range
CM119	48-Pin LQFP 7mm×7mm×1.4mm (Plastic)	0 °C to +70 °C	DVdd = 5V, AVdd = 5V

Outline Dimensions Dimensions shown in inches and (mm)

◆48-Lead Thin Plastic Quad Flatpack (LQFP)

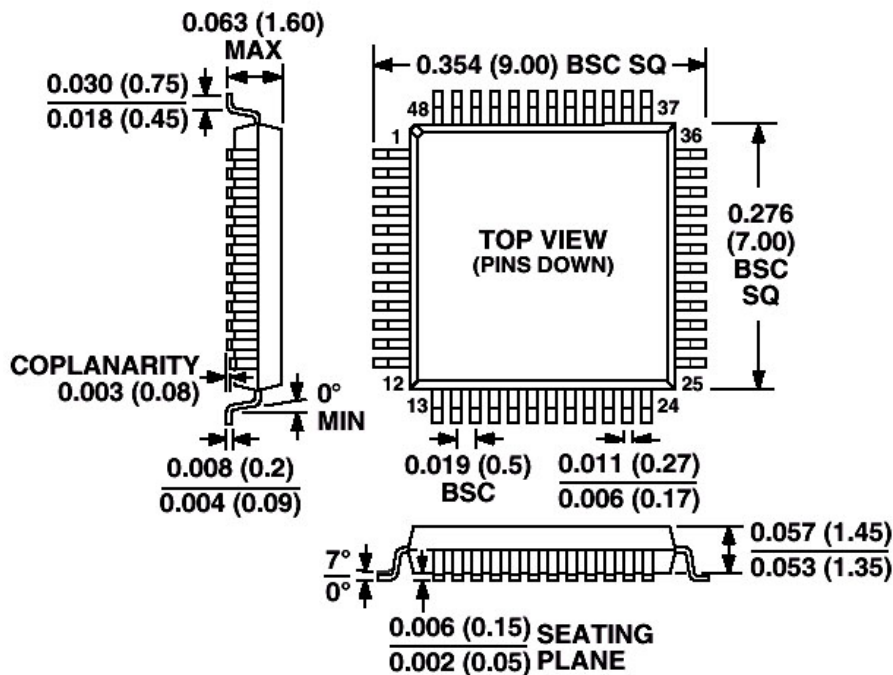

Ordering Information Of CM119

7. FUNCTION DESCRIPTIONS

7.1 USB Interface

CM119 integrates USB transceiver, PLL, and regulator so only a few passive components are necessary for the USB interface connection. Default USB descriptors are embedded in CM119; therefore no additional design effort is needed for a generic USB operation. PID changes with the jumper pin setting so different setting have different PID. For customized product, customer can attach a 93C46 EEPROM to override the embedded VID, PID and provide addition serial number for each set. CM119 automatically detects 93C46 existence and performs the overwrite function during power up.

7.1.1 Device Descriptor

Offset	Field	Size	Value (Hex)	Description
0	bLength	1	12	Total 18 Bytes
1	bDescriptorType	1	01	Device Descriptor
2	bcdUSB	2	0110	USB 1.1 compliant.
4	bDeviceClass	1	00	
5	bDeviceSubClass	1	00	
6	bDeviceProtocol	1	00	
7	bMaxPacketSize0	1	40	Endpoint zero Size = 64 bytes
8	idVendor	2	0d8c	Vendor ID
10	idProduct	2	0008 ~ 000F	Product ID Programmable by MSEL and MODE pin
12	bcdDevice	2	0100	Device compliant to the Audio Device Class specification version 1.00
14	iManufacturer	1	01	Index of string descriptor describing manufacturer
15	iProduct	1	02	Index of string descriptor describing product
16	iSerialNumber	1	03	Index of string descriptor describing the device's serial number
17	bNumConfigurations	1	01	Configurations number = 1

Note: VID, PID, and serial number can be overridden by external EEPROM content

7.1.2 Configuration Descriptor

Offset	Field	Size	Value (Hex)	Description
0	bLength	1	09	Total 9 Bytes
1	bDescriptorType	1	02	Configuration Descriptor
2	wTotalLength	2		Total length of data returned for this configuration Programmable by MSEL and MODE pin
4	bNumInterfaces	1	04 or 03	Number of interfaces supported by this Configuration (Decided by Speaker Mode and Head Set mode): 0: control interface 1: ISO-OUT interface 2: ISO-IN interface (Option) 3: INT-IN(HID) interface
5	bConfigurationValue	1	01	
6	iConfiguration	1	00	
7	bmAttributes	1	A0 or E0	Programmable by PWRSEL
8	bMaxPower	2	32 or FA	Maximum power consumption of the USB Programmable by MODE and PWRSEL

7.1.3 Content Format for 93C46

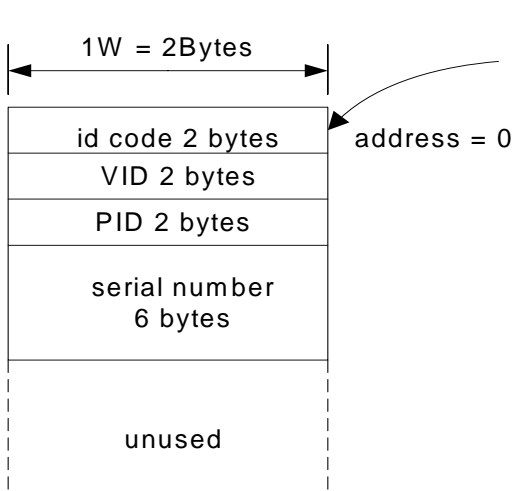

670X where X = bit 4, 3, 2, 1
bit 2 serial number enable control 1: enable 0: disable
bit 1 product string enable control 1: enable 0: disable

Content Format for 93C46

7.1.4 USB Audio Topology Diagram

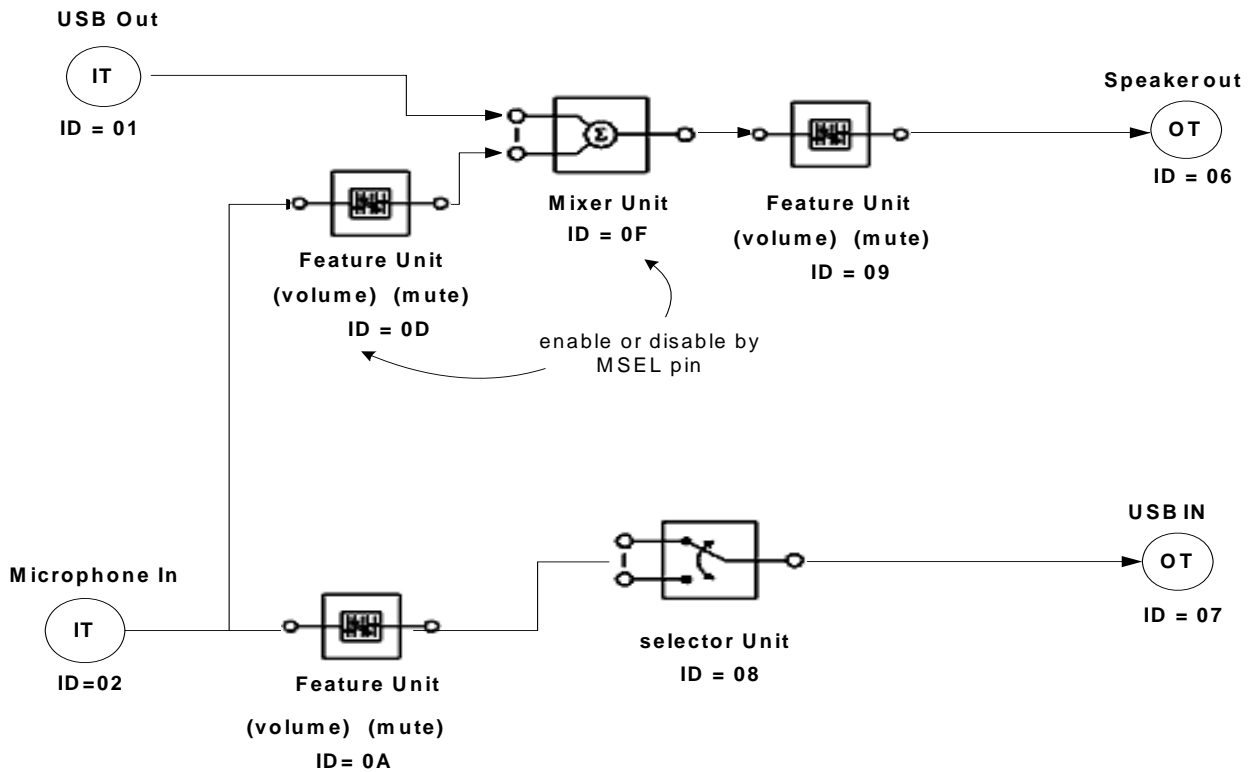

USB Audio Topology Diagram

7.2 Jumper Pins and Mode Setting:

Several jumper pins can set the configuration of CM119. These jumper pin settings affect both USB descriptors and USB audio topology. If MODE pin is pulled up to 3.3V (speaker mode), a playback only function is activated and there is no recording function declared to the host. At this setting, MSEL pin is ignored and only one input terminal, one output terminal and one feature unit is declared in USB audio topology.

If MODE pin is pulled low (headset mode), a full duplex playback and recording function is reported to the host. MSEL pin setting activates one mixer unit and one feature unit. The following USB audio topology in Chapter: 7.1.4 is an example of headset mode. PWRSEL pin affects the power configuration of CM119; together with MODE pin totally 4 combinations are programmable.

Combinations		MODE	
		3.3V	GND
PWRSEL	3.3V	Speaker Mode : Playback Only (Self Power with 100mA)	Headset Mode : Playback + Recording (Bus Power with 100mA)
	GND	Speaker Mode : Playback Only (Bus Power with 500mA)	Headset Mode : Playback + Recording (Bus Power with 500mA)

VSEL jumper pin sets the output voltage swing. When VSEL is connected to 5V, output voltage swing is 3.5Vpp; when VSEL is connected to ground, output voltage is 2.5Vpp.

7.3 HID Feature and Descriptions

HID feature is provided by CM119 so user setting to volume up, volume down, and playback mute button pin is reported to the host to synchronize host side setting. In addition, all CM119 internal registers can be accessed via HID function call.

USB protocols can configure devices at startup or when they are plugged in at run time. These devices are broken into various device classes. Each device class defines the common behavior and protocols for devices that serve similar functions. The HID (Human Interface Device) class is one of the device classes.

The HID class consists primarily of devices that are used by humans to control the operation of computer systems. Typical examples of HID class devices include:

- Keyboards and pointing devices, for example: mouse, trackballs, and joysticks.
- Front-panel controls, for example: knobs, switches, buttons, and sliders.
- Controls that might be found on devices such as VCR remote controls, games or simulation devices, for example: data gloves, throttles, and steering wheels.
- Devices that may not require human interaction but provide data in a similar format to HID class devices, for example: bar-code readers, thermometers, or voltmeters.

7.3.1 HID Descriptor

HID Interface Descriptor

Offset	Field	Size	Value (Hex)	Description
0	bLength	1	09	Size of this descriptor: 9 byte
1	bDescriptorType	1	04	INTERFACE descriptor type
2	bInterfaceNumber	1	03	Number of Interface: 3
3	bAlternateSetting	1	00	alternate 0
4	bNumEndpoints	1	01	Number of endpoints used by this Interface: 1
5	bInterfaceClass	1	03	HID Interface Class
6	bInterfaceSubClass	1	00	No Subclass
7	bInterfaceProtocol	1	00	Must be set to 0
8	iInterface	1	00	Index of a string descriptor that describes this interface.

HID Descriptor

Offset	Field	Size	Value (Hex)	Description
0	bLength	1	09	Total 9 Bytes
1	bDescriptorType	1	21	HID Descriptor Type
2	bcdHID	2	0100	HID class version 1.00
4	bCountryCode	1	00	
5	bNumDescriptors	1	01	
6	bDescriptorType	1	22	Report Descriptor
7	wDescriptorLength	2	0030	Numeric expression that is the total size of the optional descriptor: 48 Bytes

Interrupt IN Endpoint Descriptor

Offset	Field	Size	Value (Hex)	Description
0	bLength	1	07	Total 7 Bytes
1	bDescriptorType	1	05	ENDPOINT Descriptor Type
2	bEndpointAddress	1	83	IN Endpoint Endpoint number = 3
3	bmAttributes	1	03	Interrupt endpoint type
4	wMaxPacketSize	2	0004	Maximum packet size: 4 bytes
6	bInterval	1	20	32ms

7.3.2 Windows Software Architecture for HID

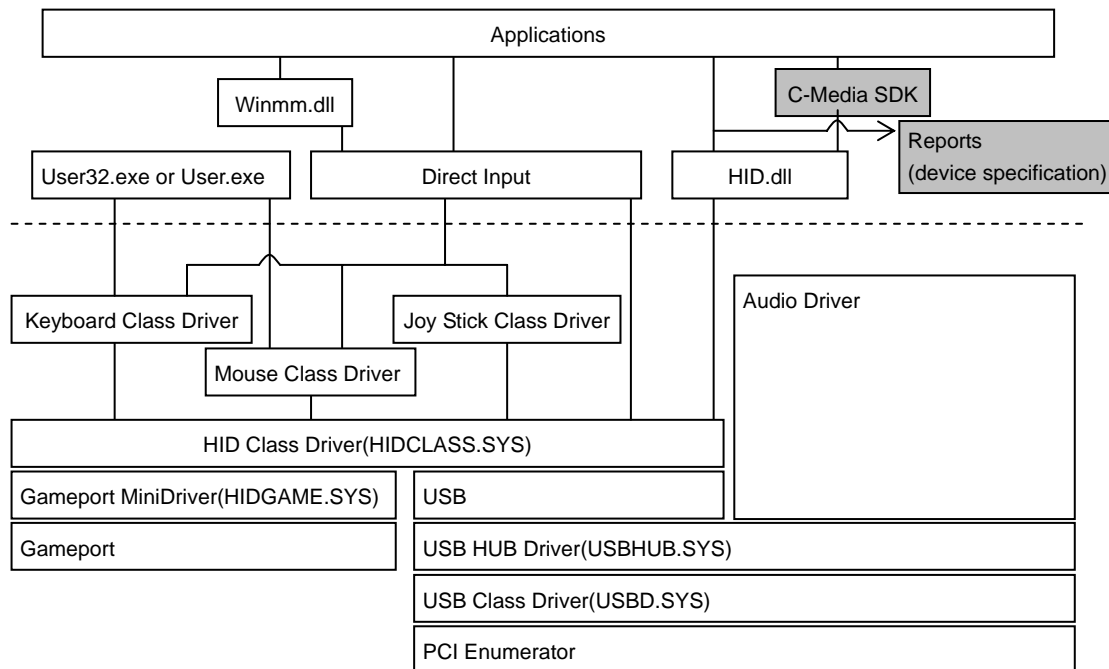

Note: Please contact with our sales for the C-Media SDK example if needed.

7.4 Internal Registers

All internal registers of CM119 can be accessed via generic HID functional calls without the need to develop kernel mode driver. Totally 4 bytes of data can be read or write from HID. Input report is for read and output report is for write. Internal registers of CM119 are used to control GPIO, S/PDIF output, EEPROM and MCU data access. Host side HID or external MCU can access CM119 internal registers. With both sides accessed to the same set of registers, two-way communication can be achieved.

7.4.1 Access via HID Class Command:

HID_IR0 to HID_IR3 are HID input report and is use by host side receiving data to CM119. HID_OR0 to HID_OR3 are HID output report and is used by host side sending adta to CM119

HID interrupt will occur when HID_IR0-3 are updated by button status MCU (and GPI in case HID_IR0[7:6] == 2'b00).

HID_IR0 (HID input report byte 0)

Offset : 0x00

Bits	Read/Write	Description	Default
7-6	R	When HID_OR0[7] == 1'b0: HID_IR0-3 are programmed by MCU (and GPI) 0: HID_IR1 is used as GPI 1: HID_IR0-3 are used as generic HID registers 2: Values written to HID_IR0-3 are also mapped to MCU_CTRL, EEPROM_DATA0-1, EEPROM_CTRL 3: Reserved	0x0
5-4	R	When HID_OR0[7] == 1'b0: Generic registers programmed by MCU When HID_OR0[7] == 1'b1: Mapped from MCU_CTRL[5:4]	0x0
3	R	0: No activity on Record-Mute button 1: Record-Mute button pressed then released	0x0
2	R	0: No activity on Playback-Mute button 1: Playback-Mute button pressed then released	0x0
1	R	0: Volume-Down button released 1: Volume-Down button pressed	0x0
0	R	0: Volume-Up button released 1: Volume-Up button pressed	0x0

HID_IR1 (HID input report byte 1)

Offset : 0x01

Bits	Read/Write	Description	Default
7-0	R	When HID_OR0[7] == 1'b0: GPI (when HID_IR0[7:6] == 2'b00); or Generic registers programmed by MCU (otherwise) When HID_OR0[7] == 1'b1: Mapped from EEPROM_DATA0	0x00

HID_IR2 (HID input report byte 2)

Offset : 0x02

Bits	Read/Write	Description	Default
7-0	R	When HID_OR0[7] == 1'b0: Generic registers programmed by MCU When HID_OR0[7] == 1'b1: Mapped from EEPROM_DATA1	0x00

HID_IR3 (HID input report byte 3)

Offset : 0x03

Bits	Read/Write	Description	Default
7-0	R	When HID_OR0[7] == 1'b0: Generic registers programmed by MCU When HID_OR0[7] == 1'b1: Mapped from EEPROM_CTRL	0x00

HID_OR0 (HID output report byte 0)

Offset : 0x04

Bits	Read/Write	Description	Default
7-6	R/W	0: HID_OR1-2 are used for GPO; HID_OR0, 3 are used for buzzer and SPDIF 1: HID_OR0-3 are used as generic HID registers 2: Values written to HID_OR0-3 are also mapped to MCU_CTRL, EEPROM_DATA0-1, EEPROM_CTRL (see Note) 3: Reserved	0x0
5	R/W	When HID_OR0[7] == 1'b0: 0: Buzzer off 1: Buzzer on When HID_OR0[7] == 1'b1: Mapped to MCU_CTRL[5]	0x0
4	R/W	When HID_OR0[7] == 1'b0: Valid bit in SPDIF frame When HID_OR0[7] == 1'b1: Mapped to MCU_CTRL[4]	0x0
3-0	R/W	When HID_OR0[7] == 1'b0: First nibble of SPDIF status channel When HID_OR0[7] == 1'b1: Reserved	0x0

Note : When EEPROM access is done, HID interrupt will occur. USB host can get the result from interrupt pipe (endpoint 3).

HID_OR1 (HID output report byte 1)

Offset : 0x05

Bits	Read/Write	Description	Default
7-0	R/W	When HID_OR0[7:6] == 2'b00: 0: GPO drives L 1: GPO drives H When HID_OR0[7:6] == 2'b01: Generic HID registers When HID_OR0[7:6] == 2'b1x: Mapped to EEPROM_DATA0	0x00

HID_OR2 (HID output report byte 2)

Offset : 0x06

Bits	Read/Write	Description	Default
7-0	R/W	When HID_OR0[7:6] == 2'b00: 0: Set GPIO to input mode 1: Set GPIO to output mode When HID_OR0[7:6] == 2'b01: Generic HID registers When HID_OR0[7:6] == 2'b1x: Mapped to EEPROM_DATA1	0x00

HID_OR3 (HID output report byte 3)

Offset : 0x07

Bits	Read/Write	Description	Default
7-0	R/W	When HID_OR0[7] == 1'b0: Category byte of SPDIF status channel When HID_OR0[7] == 1'b1: Mapped to EEPROM_CTRL	0x00

Note: HID_OR3 is used for SPDIF when SPDIF_CONFIG[5] == 1'b0

7.4.2 Access via External Serial Interface by MCU:

External MCU can write data to HID_IR0 to HID_IR3 and read data from HID_OR0 to HID_OR3. MINT will be active when HID_OR0-3 are updated by Set_Output_Report HID class command, and will be cleared after HID_OR0-3 are read by MCU.

HID_IR0 (HID input report byte 0)

Offset : 0x00

Bits	Read/Write	Description	Default
7-6	R/W	0: HID_IR0-3 are not used by MCU 1: HID_IR0-3 are used as generic HID registers 2: Values written to HID_IR0-3 are also mapped to MCU_CTRL, EEPROM_DATA0-1, EEPROM_CTRL (see Note) 3: Reserved	0x0
5	R/W	When HID_IR0[7] == 1'b0: 0: Buzzer off 1: Buzzer on When HID_IR0[7] == 1'b1: Mapped to MCU_CTRL[5]	0x0
4	R/W	When HID_IR0[7] == 1'b0: Generic HID register When HID_IR0[7] == 1'b1: Mapped to MCU_CTRL[4]	0x0
3	R	0: No activity on Record-Mute button 1: Record-Mute button pressed then released	0x0
2	R	0: No activity on Playback-Mute button 1: Playback-Mute button pressed then released	0x0
1	R	0: Volume-Down button released 1: Volume-Down button pressed	0x0
0	R	0: Volume-Up button released 1: Volume-Up button pressed	0x0

Note: When EEPROM access is done, MINT will be active. MCU should read HID_OR0-3 to get the result, and then MINT will be cleared.

HID_IR1 (HID input report byte 1)

Offset : 0x01

Bits	Read/Write	Description	Default
7-0	R/W	When HID_IR0[7] == 1'b0: Generic HID registers When HID_IR0[7] == 1'b1: Mapped to EEPROM_DATA0	0x00

HID_IR2 (HID input report byte 2)

Offset : 0x02

Bits	Read/Write	Description	Default
7-0	R/W	When HID_IR0[7] == 1'b0: Generic HID registers When HID_IR0[7] == 1'b1: Mapped to EEPROM_DATA1	0x00

HID_IR3 (HID input report byte 3)

Offset : 0x03

Bits	Read/Write	Description	Default
7-0	R/W	When HID_IR0[7] == 1'b0: Generic HID registers When HID_IR0[7] == 1'b1: Mapped to EEPROM_CTRL	0x00

HID_OR0 (HID output report byte 0)

Offset : 0x04

Bits	Read/Write	Description	Default
7-6	R	When HID_IR0[7] == 1'b0: HID_OR0-3 are programmed by USB host 0: HID_OR1-2 are used for GPO 1: HID_OR0-3 are used as generic HID registers 2: Values written to HID_OR0-3 are also mapped to MCU_CTRL, EEPROM_DATA0-1, EEPROM_CTRL 3: Reserved When HID_IR0[7] == 1'b1: Always 2'b11	0x0
5-4	R	When HID_IR0[7] == 1'b0: Generic registers programmed by USB host When HID_IR0[7] == 1'b1: Mapped from MCU_CTRL[5:4]	0x0
3-0	R	When HID_IR0[7] == 1'b0: Generic registers programmed by USB host When HID_IR0[7] == 1'b1: Always 4'h0	0x0

HID_OR1 (HID output report byte 1)

Offset : 0x05

Bits	Read/Write	Description	Default
7-0	R	When HID_IR0[7] == 1'b0: Generic registers programmed by USB host When HID_IR0[7] == 1'b1: Mapped from EEPROM_DATA0	0x00

HID_OR2 (HID output report byte 2)

Offset : 0x06

Bits	Read/Write	Description	Default
7-0	R	When HID_IR0[7] == 1'b0: Generic registers programmed by USB host When HID_IR0[7] == 1'b1: Mapped from EEPROM_DATA1	

HID_OR3 (HID output report byte 3)

Offset : 0x07

Bits	Read/Write	Description	Default
7-0	R	When HID_IR0[7] == 1'b0: Generic registers programmed by USB host When HID_IR0[7] == 1'b1: Mapped from EEPROM_CTRL	0x00

7.4.3 Indirect Accessed Registers:

MCU_CTRL (MCU control)

Offset : 0x08

Bits	Read/Write	Description	Default
7-6	--	Reserved	0x0
5-4	R/W	0: MCLK operating at 1.5MHz 1: MCLK operating at 3MHz 2: MCLK operating at 6MHz 3: Reserved	0x0
3-0	--	Reserved	0x0

EEPROM_DATA0 (Low byte of EEPROM data)

Offset : 0x09

Bits	Read/Write	Description	Default
7-0	R/W	Low byte of EEPROM data to be accessed	0x00

EEPROM_DATA1 (High byte of EEPROM data)

Offset : 0x0a

Bits	Read/Write	Description	Default
7-0	R/W	High byte of EEPROM data to be accessed	0x00

EEPROM_CTRL (Serial EEPROM access control)

Offset : 0x0b

Bits	Read/Write	Description	Default
7	R/W	When Register Read: 0: No EEPROM access pending 1: Last EEPROM access pending When Register Write: 0: No action 1: Start EEPROM access (will clear to 0 automatically)	0x0
6	R/W	0: Read EEPROM 1: Write EEPROM	0x0
5-0	R/W	Address of serial EEPROM	0x00

7.5 MCU Interface

On MCU serial interface, CM119 serves as a slave device with bit rate up to 400Kbps (fast mode). MCU can read/write 3 bytes to CM119 device with a 2-bit register address. Since host side and MCU can both access to all the internal registers, access contention when both host and MCU try to access the same register should be avoided on application. The 7-bit slave address of CM119 is assigned as 7'b0111000.

When a one-byte data is written by MCU, CM119 will transfer totally 4 bytes to the USB host via an additional interrupt pipe. The sequence of the upward HID report is the button status first (address 00), then register with address 01, then register with address 02, then register with address 03. The USB host will keep polling the upward HID

report every 32mS. When there is any button pressed or released, or MCU data coming, CM119 will transfer the 4 bytes of HID report to the USB host again.

CM119 can also transfer one byte MCU data from the USB host to its register. This is accomplished by a 'Set Output Report' HID class request via default control pipe. MCU can get this downward byte by interrupt or polling.

CM119 has one input pin 'SCLK' where it gets serial clock from MCU, and one open-drain output pin 'SDAT' where it sends or receives serial signal to/from MCU. As shown below, 'SDAT' should be stable when 'SCLK' is high, and can have transition only when 'SCLK' is low.

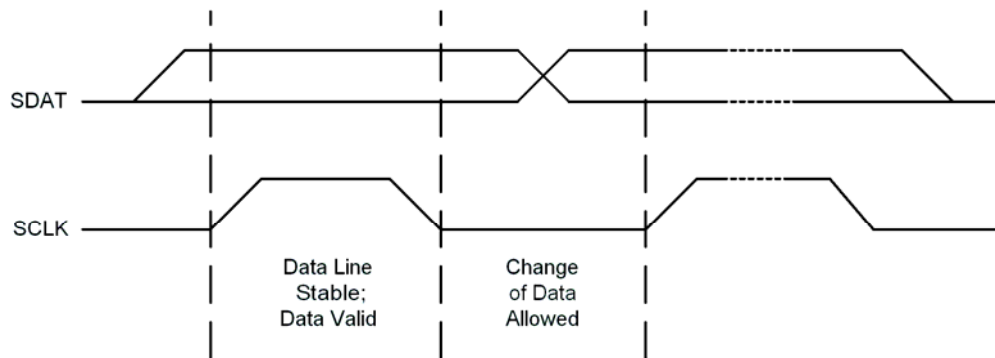

Bit Transfer on the MCU Interface

START and STOP conditions shown below are the exception. Every transaction begins from a START, and ends with a STOP, or another START (repeated START).

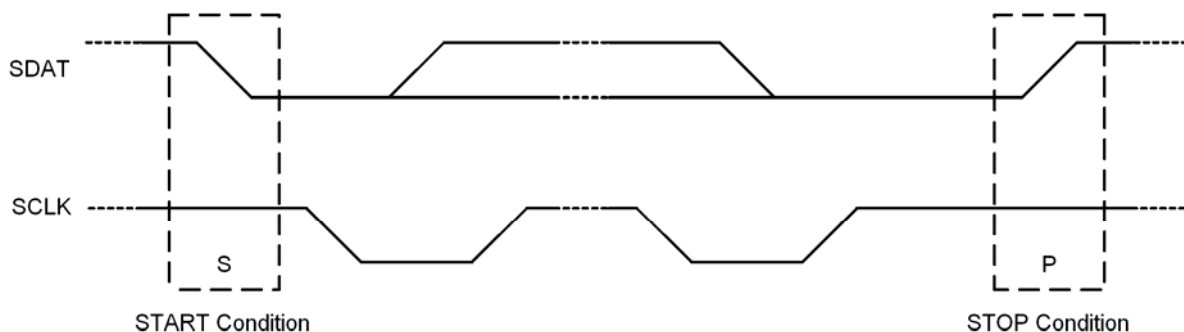

START and STOP Conditions

The figure below demonstrates a typical transaction. After every 8 bits sent by the transmitter, the receiver should send one bit low for positive acknowledgement or one bit high for negative acknowledgement. After the negative acknowledgement, a STOP or repeated START should follow. The next figure shows more detailed about acknowledgement bit. Note that 'SCLK' is always driven by the master.

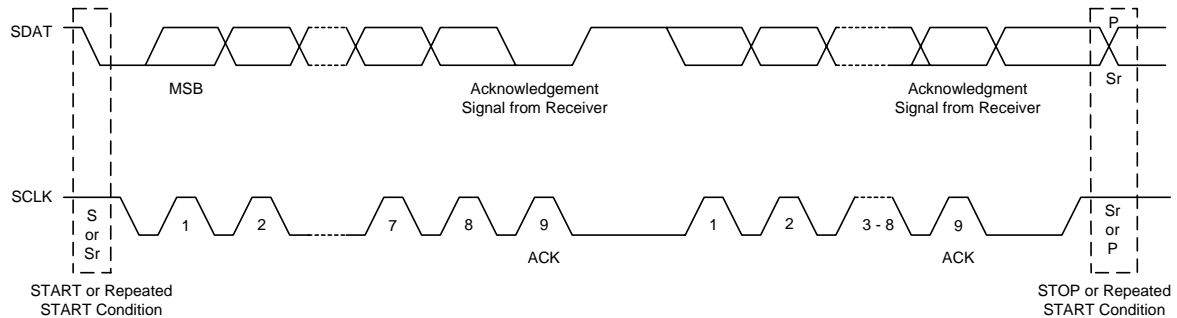

Data Transfer on the MCU Interface

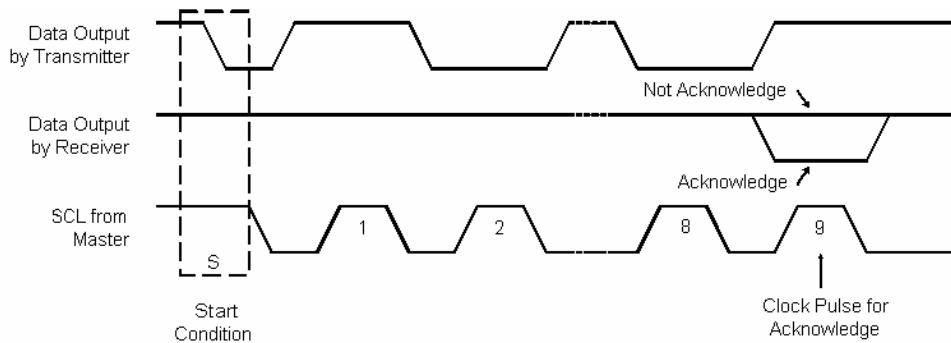

Acknowledge on the MCU Interface

The figure below shows a complete data transfer. After a START, MCU should send 7-bit slave address (7'b0111000) first, and then the 8th bit denotes a read transfer when it's high; or a write transfer when it's low. The first acknowledgement is always from CM119.

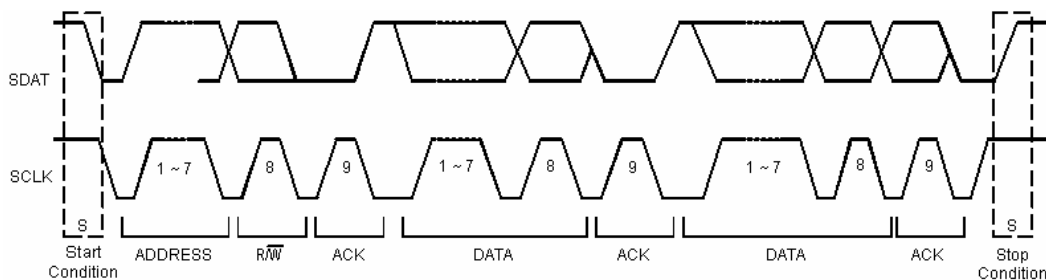

A Complete Data Transfer

In the write transfer, MCU keep acting as the master and the transfer direction is not changed. The following figure gives an example of one byte write transfer.

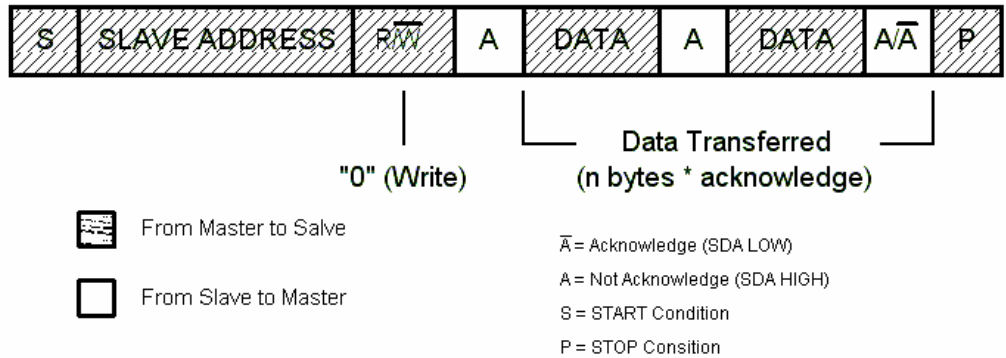

**A Master-Transmitter Addressing a Slave Receiver with a 7-bit Address.
The Transfer Direction is not Changed.**

CM119 regards the first DATA byte as the register address. The second DATA byte is the content that MCU writes at the register address. If there is the third DATA byte, CM119 will auto-increment this byte to the next register address.

The figure below shows an example of two bytes read transfer. Because CM119 has auto-increment function, the second DATA byte will be the register data on the next address.

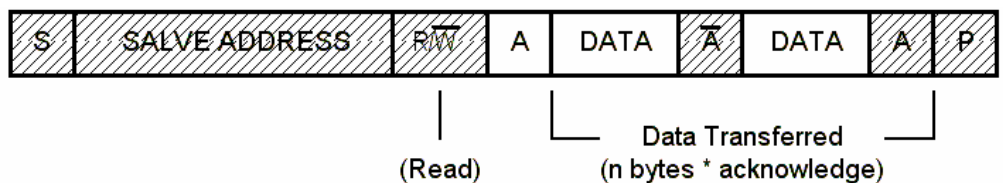

A Master reads a Salve immediately after the first Byte

Please note that the USB host tries to get new HID data every 32mS. It's quite slow. If the continuous write transfers are too close in time, the former transfer may have no effect.







The figure below shows typical transactions between MCU and CM119. After a START, MCU should send 7-bit slave address (0111000) first, and then the 8th bit denotes a read transfer when it's high; or a write transfer when it's low.

MCU write:

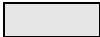
S	0x70	0	0x00	0	Byte 0	0	Byte 1	0	Byte 2	0	Byte 3	0	P
---	------	---	------	---	--------	---	--------	---	--------	---	--------	---	---

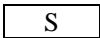
MCU read:

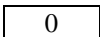
S	0x70	0	0x04	0									
S	0x71	0	Byte 0	0	Byte 1	0	Byte 2	0	Byte 3	1			P

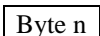
	From CM119 to MCU		From MCU to CM119
	START condition		STOP condition
	Positive acknowledge		Negative acknowledge
	One byte data (address n)		

In a write transfer, MCU keeps acting as the transmitter. CM119 regards the first DATA byte as start register address (it's better to be 0x00). The following four DATA bytes are the content that MCU writes to the register addresses. In a read transfer, two transactions are necessary. MCU resets start register address by the first transaction. Then MCU changes to be the receiver during the second transaction to get four bytes of data.

Note 1: Bits 0~3 of the first HID byte always reflect button activity, so they can not be written by MCU.

7.6 Buzzer Output

Each time the software set "1" to the register HID-OR0 bit 5, an embedded ringing sequence is played once. Since the delay between one sequence and next sequence is long (around 1 second ~ 2 second), this delay to be set by software, H/W only play one sequence and then stop for one register write.

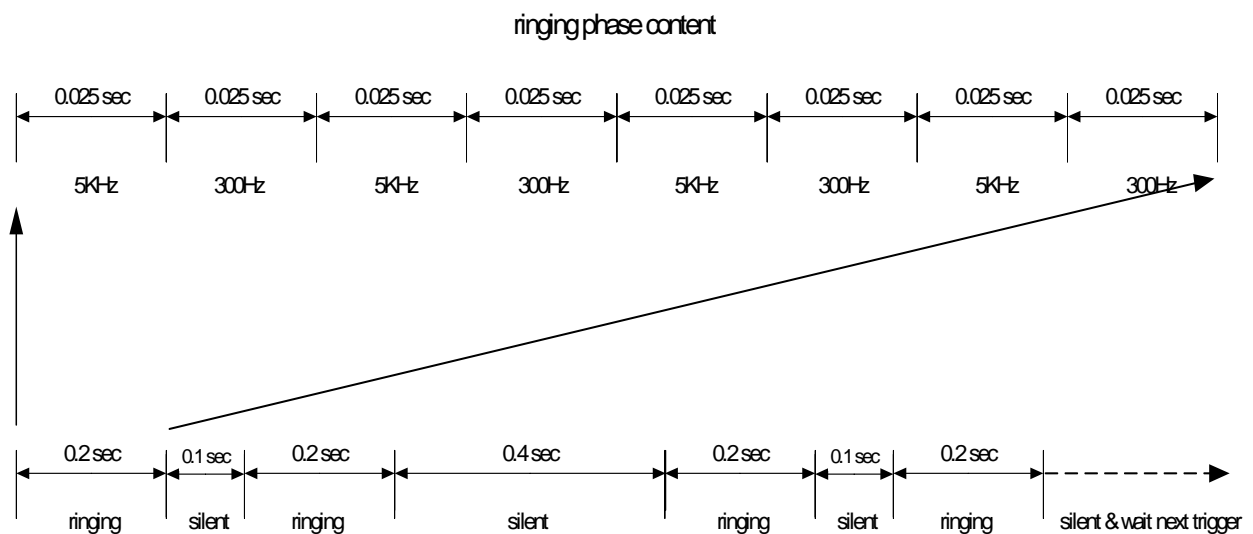

8. ELECTRICAL CHARACTERISTICS

8.1 Absolute Maximum Rating

Symbol	Parameter	Value	Unit
Dvmin	Min Digital Supply Voltage	- 0.3	V
Dvmax	Max Digital Supply Voltage	+ 6	V
Avmin	Min Analog Supply Voltage	- 0.3	V
Avmax	Max Analog Supply Voltage	+ 6	V
Dvinout	Voltage on any Digital Input or Output Pin	-0.3 to +5.5	V
Avinout	Voltage on any Analog Input or Output Pin	-0.3 to +5.5	V
T _{stg}	Storage Temperature Range	-40 to +125	°C
ESD (HBM)	ESD Human Body Mode	3500	V
ESD (MM)	ESD Machine Mode	200	V

8.2 Operation Conditions

Operation conditions				
	Min	Typ	Max	Unit
Analog Supply Voltage	4.5	5.0	5.5	V
Digital Supply Voltage	4.5	5.0	5.5	V
Total Power Consumption	-	-	70	mA
Suspend Mode Power Consumption	-	320	-	uA
Operating ambient temperature	0	-	70	°C

8.3 Electrical Parameters

	Min	Typ	Max	Unit
DAC (10K Ohm Loading)				
Resolution	-	16	-	Bits
THD + N (-3dBr)	-	-74.29	-	dB
SNR	-	93.6	-	dB
Silent SNR	-	98.2	-	dB
Dynamic range	-	93.8	-	dB
Frequency response 48KHz	20	-	20K	Hz
Frequency Response 44.1KHz	20	-	20K	Hz
Output Boltage (rms)	-	1.25	-	Vrms
Output Voltage Swing	0.5	-	4.0	V
DAC (32 Ohm Loading)				
Resolution	-	16	-	Bits
THD + N (-3dBr)	-	-71.1	-	dB
SNR	-	93.7	-	dB
Silent SNR	-	98.2	-	dB
Dynamic Range	-	93.8	-	dB
Frequency Response 48KHz	20	-	20K	Hz
Frequency Response 44.1KHz	20	-	20K	Hz
Output Voltage (rms)	-	1.25	-	Vrms
Output Voltage Swing	0.5	-	4.0	V
ADC				
Resolution	-	16	-	bit
THD + N (-3dBr)	-	-76.1	-	dB
SNR	-	83.1	-	dB
Dynamic Range	-	81.6	-	dB
Frequency Response 48KHz	20	-	19.2	Hz
Frequency Response 44.1KHz	20	-	17.6	Hz
Input Range	0	-	2.88	Vpp
Amplification				
Volume Control Level	-45	-	0	dB
Volume Control Step	-	38	-	Steps
Microphone Input				
Boost Gain	-	+20	-	dB
Gain Adjustment Range	0	-	22.5	dB
Gain Adjustment Steps	-	16	-	Steps
Mixer Gain Adjustment	-33.0	-	12.0	dB
Mixer Gain Adjustment Steps	-	32	-	Steps

9. FREQUENCY RESPONSE GRAPHS

9.1 Digital Playback for Line Output Frequency (10K Ohm Loading)

9.1.1 Frequency Response 48Ks/Sec (10K Ohm Loading)

C-media Digital Playback (PC-D-A) for Line Output Frequency 07/15/03 19:03:14
Response

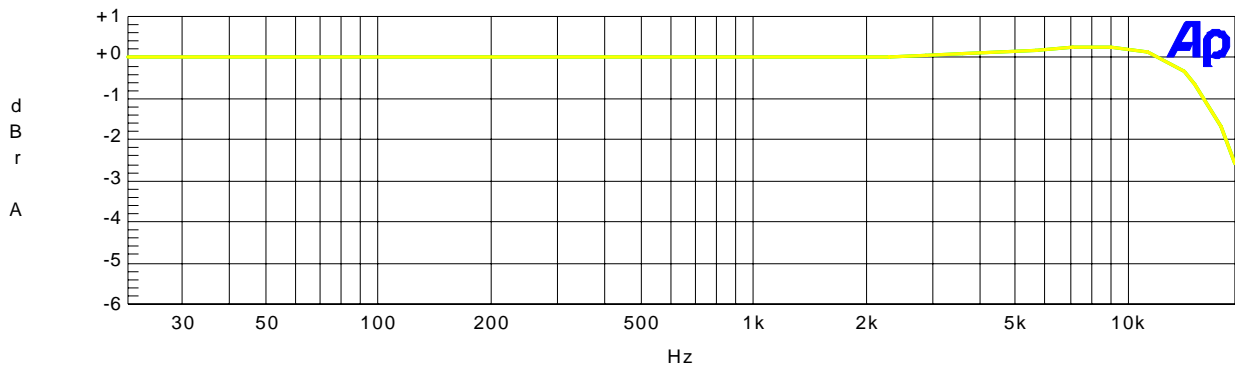

Color	Line Style	Thick	Data	Axis
Green	Solid	2	Fasttest.Ch.1 Ampl!Normalize	Left
Yellow	Solid	2	Fasttest.Ch.2 Ampl!Normalize	Left

WL-Multitone-48k.at2

9.1.2 Frequency Response 44.1Ks/Sec (10K Ohm Loading)

C-media Digital Playback (PC-D-A) for Line Output Frequency 07/15/03 19:05:40
Response

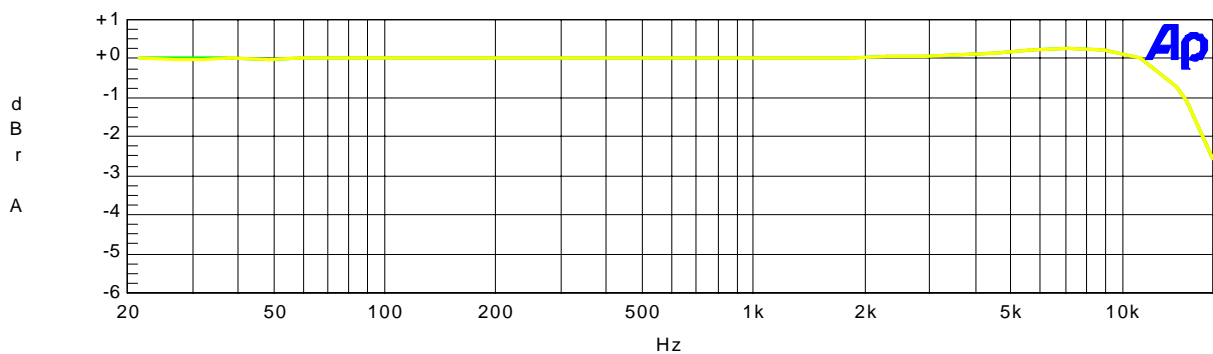

Color	Line Style	Thick	Data	Axis
Green	Solid	2	Fasttest.Ch.1 Ampl!Normalize	Left
Yellow	Solid	2	Fasttest.Ch.2 Ampl!Normalize	Left

WL-Multitone-44k.at2

9.2 Digital Playback for Line Output Frequency (32 Ohm Loading)

9.2.1 Frequency Response 48Ks/Sec (32 Ohm Loading)

C-media Digital Recording (A-D-PC) for Line Input Frequency Response

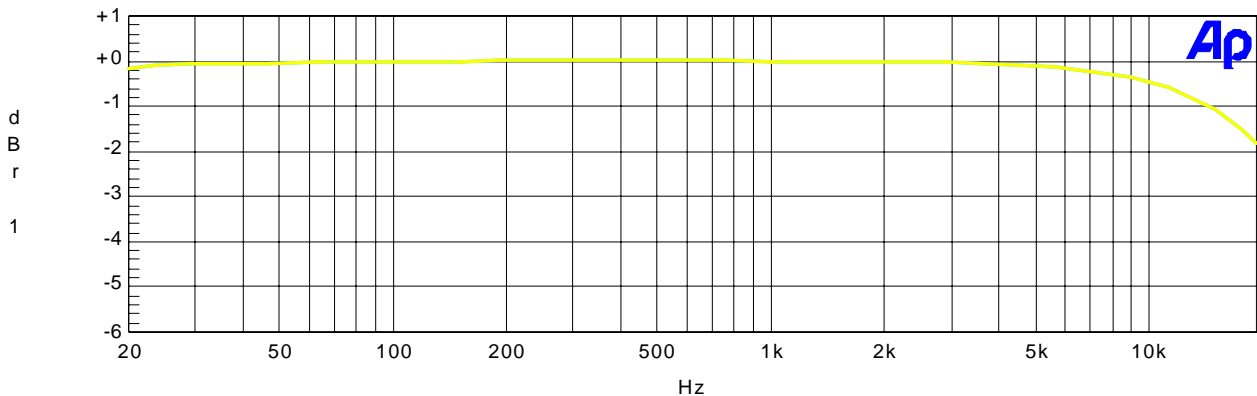

Color	Line Style	Thick	Data	Axis
Cyan	Solid	2	Fasttest.Ch.1 Ampl!Normalize	Left
Yellow	Solid	2	Fasttest.Ch.2 Ampl!Normalize	Left

LW-MFreqResp-48K.at2

9.2.2 Frequency Response 44.1Ks/Sec (32 Ohm Loading)

C-media Digital Recording (A-D-PC) for Line Input Frequency Response

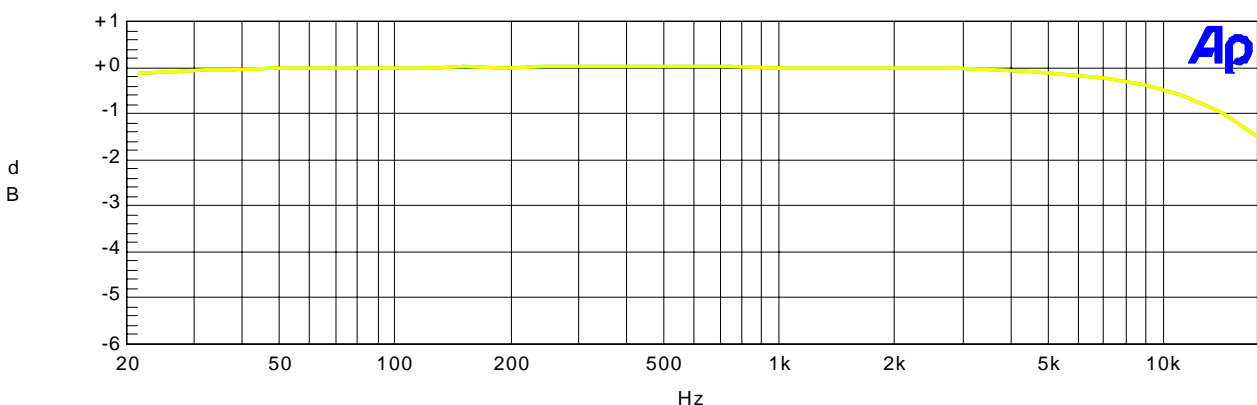

Color	Line Style	Thick	Data	Axis
Green	Solid	2	Fasttest.Ch.1 Ampl!Normalize	Left
Yellow	Solid	2	Fasttest.Ch.2 Ampl!Normalize	Left

LW-MFreqResp-44K.at2

9.3 Digital Recording for Line Output Frequency

9.3.1 Frequency Response 48Ks/Sec

C-MEDIA Digital Playback (PC-D-A) for Line Output Frequency 07/21/03 14:27:29
Response

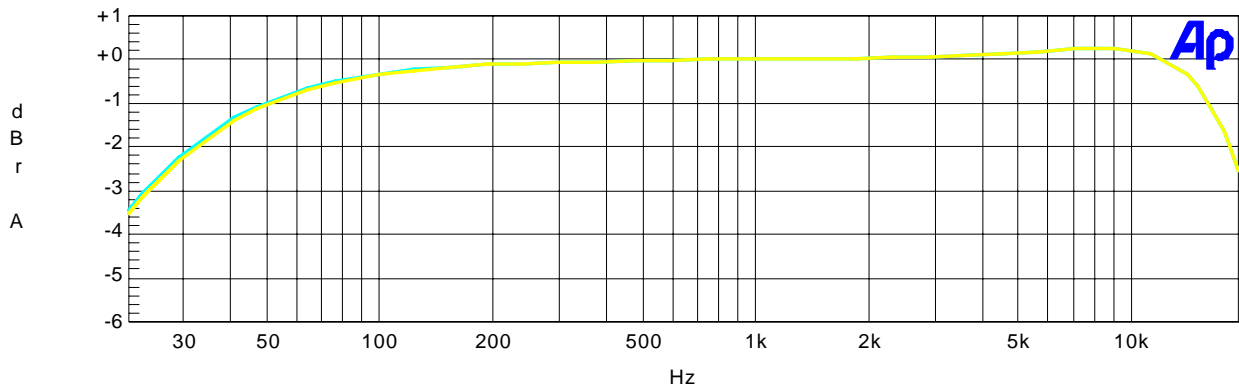

Sweep	Trace	Color	Line Style	Thick	Data	Axis	Comment
1	1	Cyan	Solid	2	Fasttest.Ch.1 Ampl!Normalize	Left	
1	2	Yellow	Solid	2	Fasttest.Ch.2 Ampl!Normalize	Left	

WL-Multitone-48k.at2c

9.3.2 Frequency Response 44.1Ks/Sec

C-MEDIA Digital Playback (PC-D-A) for Line Output Frequency 07/21/03 15:16:55
Response

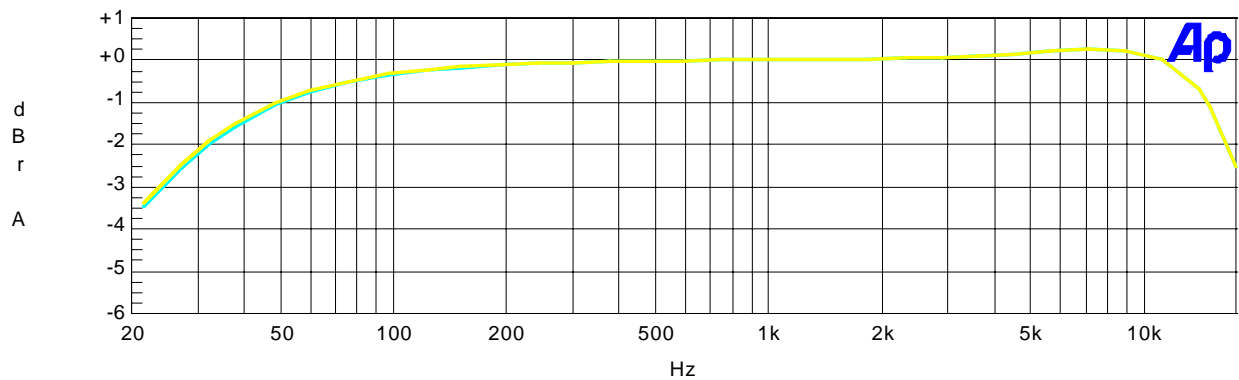

Sweep	Trace	Color	Line Style	Thick	Data	Axis	Comment
1	1	Cyan	Solid	2	Fasttest.Ch.1 Ampl!Normalize	Left	
1	2	Yellow	Solid	2	Fasttest.Ch.2 Ampl!Normalize	Left	

WL-Multitone-44k.at2c

REFERENCE

USB-IF, USB Specification, Revision 1.1 and 2.0, and USB Audio Device Class Specification, Revision 1.0,.

— End of Specifications —

C-MEDIA ELECTRONICS INC.

6F., 100, Sec. 4, Civil Boulevard, Taipei, Taiwan 106 R.O.C.

TEL:886-2-8773-1100

FAX:886-2-8773-2211

E-mail : sales@cmmedia.com.tw URL : <http://www.cmmedia.com.tw>